

EMC® VNX™ Family VNX5300™

Parts Location Guide

P/N 300-013-313

Rev 01

June 26, 2012

This guide describes one of five models available in the VNX Series, the EMC® VNX5300™. This guide is a parts location guide and provides illustrations of the part number label locations of orderable parts for the EMC VNX5300 platform. Included in this parts location guide are also tables describing the individual VNX5300 parts or components and how these components are identified as either customer replaceable units (CRUs) or field replaceable units (FRUs).

This guide is available online at <https://mydocs.emc.com/VNX/relatedDocs.jsp>. From the **VNX Hardware Parts** heading, click on the desired guide. The guide will appear in your browser.

Topics include:

◆ VNX5300 Block and File platform stackup	4
◆ VNX5300 components	7
◆ Standby power supply (SPS)	7
◆ Disk processor enclosure (DPE)	8
◆ SP power supply/cooling module	12
◆ SP	13
◆ Control Station	16
◆ Data Mover enclosure	16
◆ Data Mover Power supply/cooling fan module.....	17
◆ Data Mover CPU module.....	18
◆ Management module	21
◆ I/O modules.....	21
◆ Small form-factor pluggable (SFP)	32
◆ DIMMs	35
◆ Disk-array enclosure (DAE)	39

IMPORTANT

The part numbers listed in this guide are for reference only. Part numbers can change over time, and this document does not keep pace with those changes. The EMC parts inventory system will automatically substitute for the latest part numbers as required.

Product software and hardware release revisions

As part of an effort to improve its product lines, EMC periodically releases revisions of its software and hardware. Therefore, some functions described in this document might not be supported by all versions of the software or hardware currently in use. The product release notes provide the most up-to-date information on product features.

Contact your EMC representative if a product does not function properly or does not function as described in this document.

Note: This document was accurate at publication time. New versions of this document might be released on the EMC online support website. Check the EMC online support website to ensure that you are using the latest version of this document.

Revision history

The following table presents the revision history of this document:

Revision	Date	Description
A01	June 26, 2012	First release of the <i>VNX5300 Parts Location Guide</i> with a document part number

Where to get help

EMC support, product, and licensing information can be obtained as follows:

Product information — For documentation, release notes, software updates, or information about EMC products, licensing, and service, go to the EMC online support website (registration required) at:

<https://Support.EMC.com>

Technical support — For technical support, go to EMC online support and select Support. On the Support page, you will see several options, including one to create a service request. Note that to open a service request, you must have a valid support agreement. Contact your EMC sales representative for details about obtaining a valid support agreement or with questions about your account.

How this document is organized

The major sections of this guide are listed in the following table.

Title	Description
“VNX5300 Block and File platform stackup” on page 4	Describes and shows the front and rear views of a typical VNX5300.
“VNX5300 components” on page 7	Provides a description of the components that comprise a VNX5300. Along with a description, illustrations of each component are also shown.
“Standby power supply (SPS)” on page 7	Describes and illustrates the part number label locations of the SPS.
“Disk processor enclosure (DPE)” on page 8	Describes and illustrates the part number label locations of the DPE and the components that comprise the DPE.
“Control Station” on page 16	Describes and illustrates the part number label locations of the CS.
“Data Mover enclosure” on page 16	Describes and illustrates the part number label locations of the DME and the management module.
“I/O modules” on page 21	Describes and illustrates the part number label locations of the I/O modules that comprise the DPE and the DME.
“Small form-factor pluggable (SFP)” on page 32	Describes and illustrates the part number label locations of the SFP transceiver modules used in the DME.
“DIMMs” on page 35	Describes and illustrates the part number label locations of the memory module or dual-inline memory modules (DIMMs) used in the DPE and the DME.
“Disk-array enclosure (DAE)” on page 39	Describes and illustrates the part number label locations of the two types of DAEs available for the VNX5300.

Related documentation

EMC provides the ability to create step-by-step planning, installation, and maintenance instructions tailored to your environment. To create VNX customized documentation, go to: <https://mydocs.emc.com/VNX/>.

To download a PDF copy of the desired publication, go to the following sections:

- ◆ For hardware-related books, go to the **About VNX** section, and then select **Learn about VNX**. Next, follow the steps in the wizard.
- ◆ For technical specifications, go to the **About VNX** section, and then select **View technical specifications**. Next, follow the steps in the wizard.
- ◆ For installation, adding, or replacing tasks, go to the **VNX tasks** section, and then select the appropriate heading. For example, to download a PDF copy of the *VNX5300 Block Installation Guide*, go to **Install VNX** and follow the steps in the wizard.

- ◆ For server-related tasks, go to the **Server tasks for the VNX5300, VNX5500, VNX5700, and VNX7500** section, and then select the appropriate heading. For example, to download a PDF copy of Adding or replacing hardware, go to **Add or replace hardware** and follow the steps in the wizard.

VNX5300 Block and File platform stackup

The VNX5300 Block and File platform comprises a 1U standby power supply (SPS), a 3U disk processor enclosure (DPE), a 1U Control Station, a 2U Data Mover enclosure.

Note: Throughout this guide, figure references are placed in the **Part number label location** heading of tables because some of the tables have part number locations, as described in [Table 4 on page 11](#) and some do not, as described in [Table 1 on page 8](#), for example. This format is used throughout this guide.

Front view

On the front, viewing from top to bottom, a Block and File VNX5300 platform includes the following hardware:

- ◆ One 2U Data Mover enclosure with one to two Data Movers
- ◆ One to two 1U Control Stations
- ◆ One 3U DPE chassis with either a:
 - 15 (3.5-inch) disk drives (hot-swappable)or,
 - 25 (2.5-inch) disk drives (hot-swappable)
- ◆ One dual 1U standby power supply (SPS)

Figure 1 shows an example of the front of a Block and File VNX5300 platform with a 3U, 15 (3.5-inch) DPE.

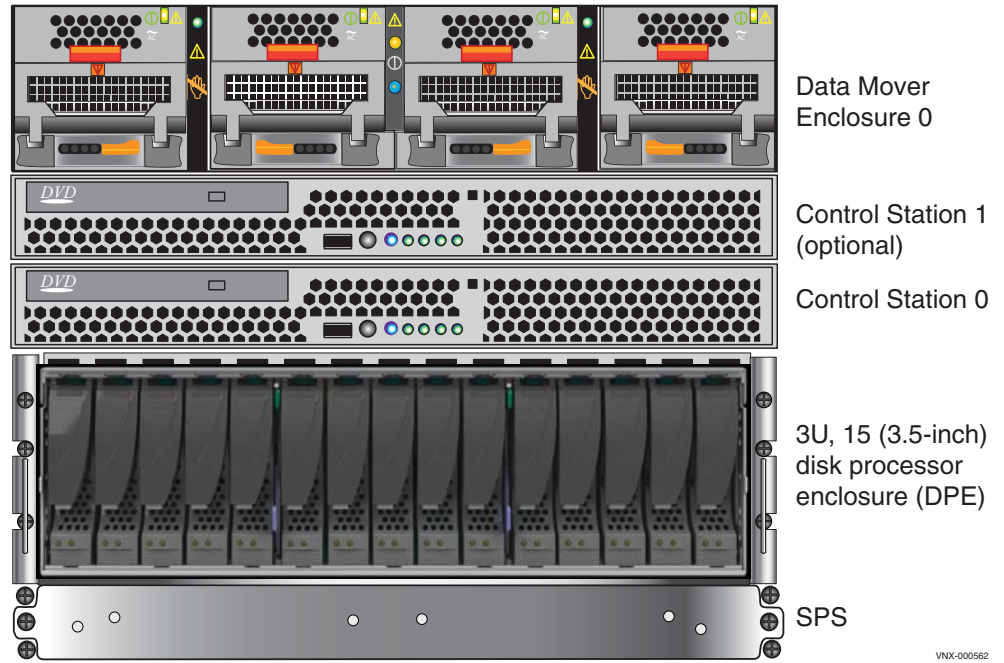

Figure 1 Example of the Block and File VNX5300 platform with a 3U, 15 (3.5-inch) DPE (front view)

Figure 2 shows an example of the front of a Block and File VNX5300 platform with a 3U, 25 (2.5-inch) DPE.

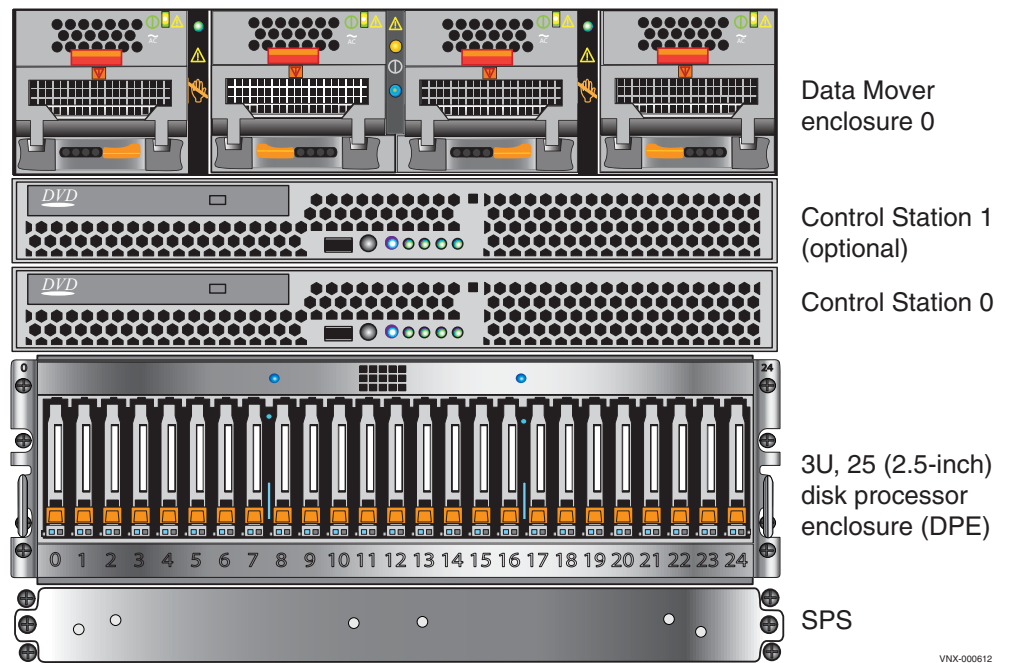

Figure 2 Example of the Block and File VNX5300 platform with a 3U, 25 (2.5-inch) DPE (front view)

Note: A Block and File VNX5300 platform has one 2U Data Mover enclosure, one 1U Control Station, one 3U DPE, and one dual 1U SPS. In the following sections, the illustrations and corresponding tables describe these individual components. These descriptions are for illustrative purposes only.

Rear view

On the rear, viewing from top to bottom, a Block and File VNX5300 platform includes the following hardware components:

- ◆ One 2U Data Mover enclosure with two Data Movers
- ◆ One to two 1U Control Stations
- ◆ One 3U DPE with two storage processors (SP A and B); each SP has one CPU module and one power supply/cooling module
- ◆ One dual 1U SPS

Figure 3 shows an example of the rear of a Block and File VNX5300 platform.

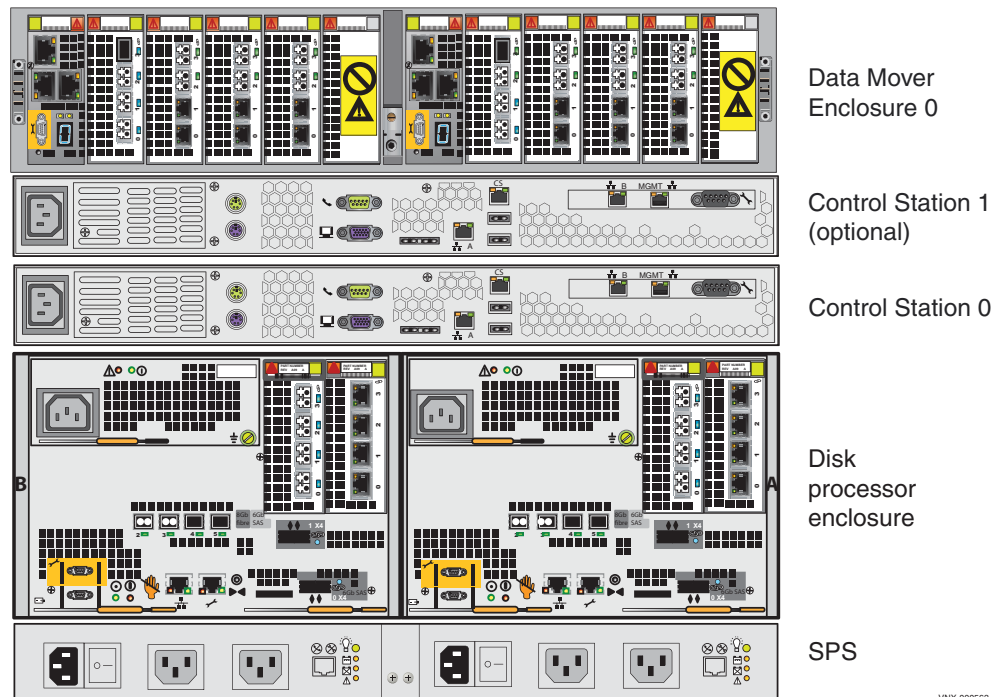

Figure 3 Example of Block and File VNX5300 platform (rear view)

VNX-000563

VNX5300 components

Viewing from the bottom to the top, the Block and File VNX5300 platform includes several components. The following sections discuss each component in an illustration and table. The illustration will show or point out the location of the part number label on the component. The table will list the part number, describe the component or part, and tell you if it is a FRU or CRU or both.

- ◆ Dual 1U standby power supply (SPS)
- ◆ 3U Disk processor enclosure (DPE)
 - 3U, 15 (3.5-inch) disk drive
 - 3U, 25 (2.5-inch) disk drive
 - Storage processor (SP) power supply/cooling module
 - Storage processor
- ◆ 1U Control Station (CS)
- ◆ 2U Data Mover enclosure (DME)
 - DME power supply/cooling module
 - DME CPU module
 - Management module
- ◆ I/O modules
 - SP I/O modules
 - DME I/O modules
- ◆ Small form-factor pluggable (SFP) transceiver modules
- ◆ Dual in-line memory modules (DIMMs)
 - SP DIMMs
 - DME DIMMs
- ◆ 2U or 3U Disk-array enclosures (DAEs)
 - 3U, 15 (3.5-inch) disk drive
 - 2U, 25 (2.5-inch) disk drive

Standby power supply (SPS)

The Block and File VNX5300 platform can support up to two standby power supplies or a dual 1U SPS to provide temporary emergency power to the Block and File VNX5300 platform. Part numbers for the 1U SPS are only on the rear of the product.

[Figure 4](#) shows the part number label location on the SPS.

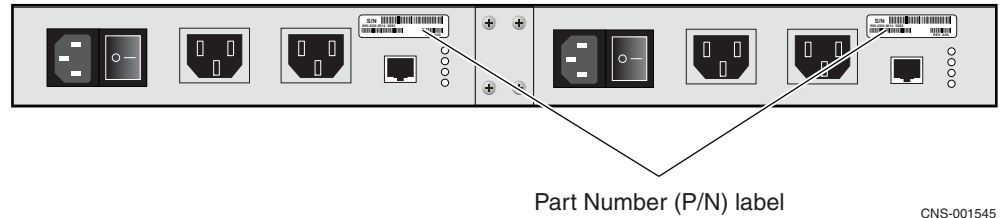

Figure 4 Example of a dual 1U SPS

[Table 5](#) lists the part number label location, part number, description, and whether it is a FRU or CRU.

Table 1 SPS part number

Part number label location (Figure 4 on page 8)	Part number	Description	FRU	CRU
	078-000-084 078-000-085	DC standby power supply (SPS) 1200W	✓	✓

Disk processor enclosure (DPE)

The 3U DPE has part numbers visible on both the front and rear.

Front view

The 3U DPE supports two types of disk drive carriers:

- ◆ 3U, 15 (3.5-inch) disk drives
- ◆ 3U, 25 (2.5-inch) disk drives

DPE 3U, 15 (3.5-inch) disk drive

[Figure 5 on page 9](#) shows the front view of the DPE 3U, 15 (3.5-inch) disk drives.

Note: You can visually distinguish disk module kinds by their type, capacity, and speed labels, and by the design of the latch and handle on each disk module ([Figure 5 on page 9](#)).

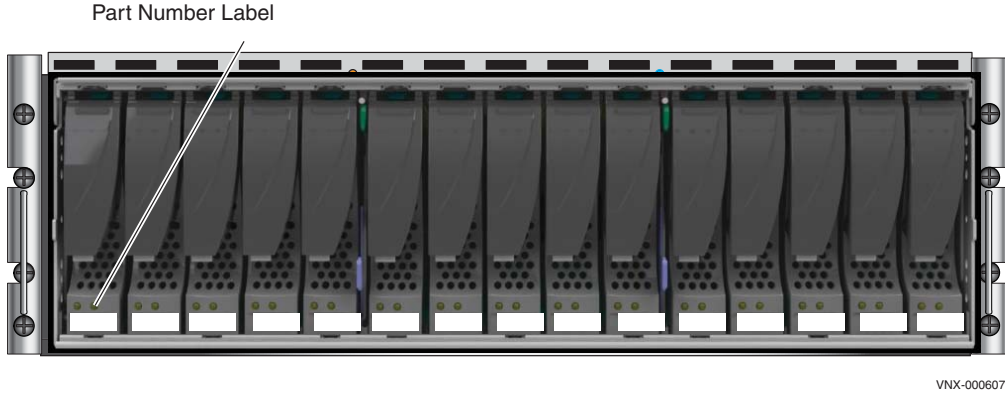

Figure 5 Example of the DPE 3U, 15 (3.5-inch) disk drive (front view)

Note: Figure 5 is for illustrative purposes only. The front of the disk modules may be a little different than the ones in your particular cabinet.

Table 2 is an example of the parts available for the 3U, 15 (3.5-inch) DPE and lists the part number label location, part number, description, and whether it is a FRU or CRU.

IMPORTANT

Due to the extensive variety of disk module types, Table 2 only lists two disk types. EMC recommends that you refer to the latest *EMC VNX5100 and VNX5300 Series Storage Systems Disk and OE Matrix Guide* to ensure that you have the correct part for your configuration.

Table 2 DPE 3U, 15 (3.5-inch) disk module part numbers

Part number label location (Figure 5)	Part number	Description (see note)	FRU	CRU
	005049299	300 GB, 6 Gb/s SAS, 10k rpm	✓	✓
	005049301	600 GB, 6 Gb/s SAS, 15k rpm	✓	✓
Note: The description field describes the disk module type, capacity, drive type, and spindle speed (rpm).				

DPE 3U, 25 (2.5-inch) disk drive

Figure 6 shows the front view of the DPE 3U, 25 (2.5-inch) disk drives.

Note: You can visually distinguish disk module kinds by their type, capacity, and speed labels, and by the design of the latch and handle on each disk module (Figure 6).

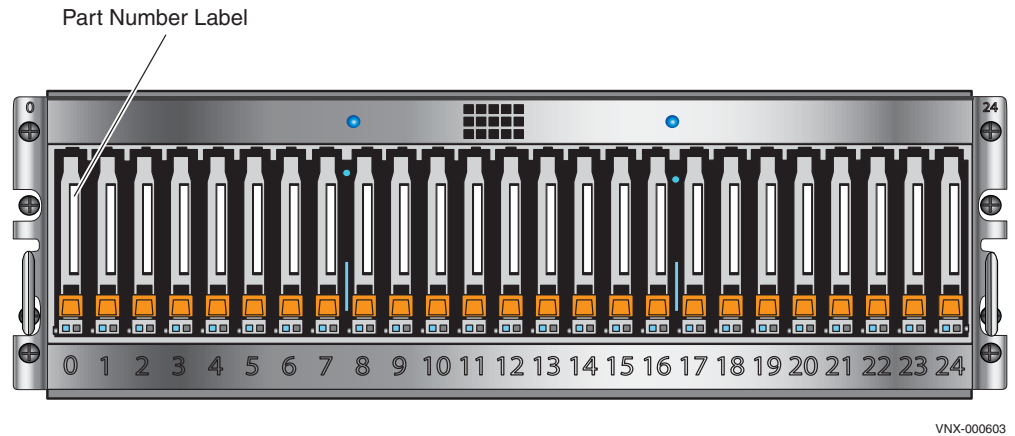

Figure 6 Example of the DPE 3U, 25 (2.5-inch) disk drive (front view)

Note: Figure 6 is for illustrative purposes only. The front of the disk modules may be a little different than the ones in your particular cabinet.

Table 3 is an example of the parts available for the 3U, 25 (2.5-inch) DPE and lists the part number label location, part number, description, and whether it is a FRU or CRU.

IMPORTANT

Due to the extensive variety of disk module types, Table 3 only lists two disk types. EMC recommends that you refer to the latest *EMC VNX5100 and VNX5300 Series Storage Systems Disk and OE Matrix Guide* to ensure that you have the correct part for your configuration.

Table 3 DPE 3U, 25 (2.5-inch) disk module part numbers

Part number label location (Figure 6)	Part number	Description (see note)	FRU	CRU
	005049292	300 GB, 6 Gb/s SAS, 10k rpm	✓	✓
	005049294	600 GB, 6 Gb/s SAS, 10k rpm	✓	✓
Note: The description field describes the disk module type, capacity, drive type, and spindle speed (rpm).				

Rear view

Figure 7 shows the rear view of the 3U disk processor enclosure (DPE) with two storage processors (SP A and B).

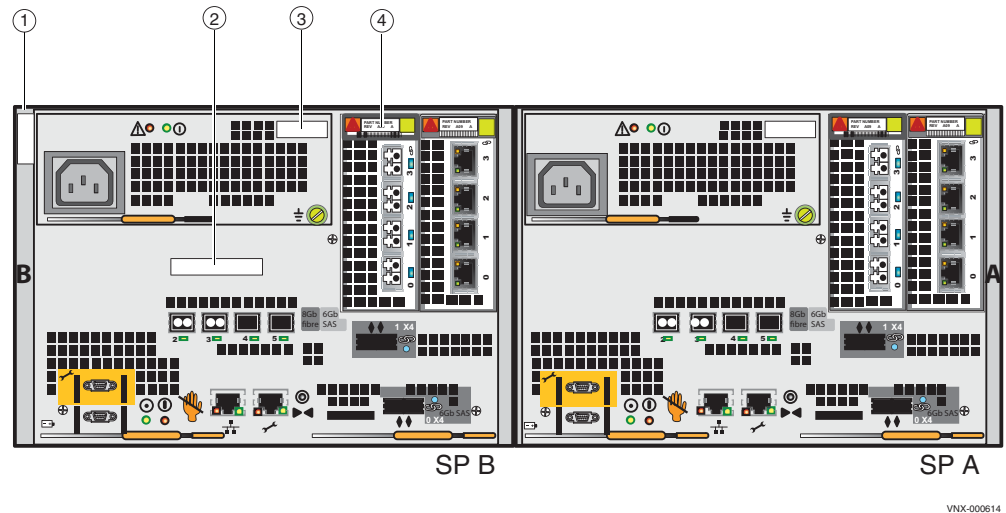

Figure 7 Example of 3U DPE with two SPs (A and B)

Table 4 lists the part number label location, part number, description, and whether it is a FRU or CRU.

Table 4 DPE chassis and SP part numbers

Part number label location (Figure 7 on page 11)	Part number	Description	FRU	CRU
1	100-562-503	3U, 15 disk drive chassis and midplane	✓	✓
	100-563-138	3U, 25 disk drive chassis and midplane	✓	✓
2	110-140-408B	SP, 1.6 GHZ QC CPU, 8-GB RAM (for a closer view, see Figure 9 on page 13)		
	110-140-400B	SP, 1.6-GHz GHZ QC CPU, DIMMs (for a closer view, see Figure 9 on page 13)	✓	
3	071-000-529	1U AC/DC, 875W, dual power supply (for a closer view, see Figure 8 on page 12)	✓	✓
4	303-092-102B	Four-port 8-Gb/s FC (2/4/8 Gb/s)	✓	✓
	303-141-100A ¹	Four-port 1-Gb/s copper iSCSI I/O module	✓	✓
	303-081-105B ²	Two-port 10-Gb/s optical with iSCSI protocol I/O module	✓	✓

Table 4 DPE chassis and SP part numbers (continued)

Part number label location (Figure 7 on page 11)	Part number	Description	FRU	CRU
	303-142-100A ³	Two-port 10-Gb/s FCoE I/O module	✓	✓
	303-164-104D-01 ⁴	Two-port 10-Gb/s RJ-45 Base-T iSCSI/IP	✓	✓
	100-562-718	I/O module filler panel includes a Do Not Remove label Note: This filler panel is only used when the SP I/O module slots are empty.		

1. This part is not shown in the example DPE illustration in Figure 7. For a closer view, go to Figure 21 on page 24.
2. This part is not shown in the example DPE illustration in Figure 7. For a closer view, go to Figure 22 on page 25.
3. This part is not shown in the example DPE illustration in Figure 7. For a closer view, go to Figure 23 on page 26.
4. This part is not shown in the example DPE illustration in Figure 7. For a closer view, go to Figure 24 on page 27.

SP power supply/cooling module

Figure 8 shows the part number label location on power supply/cooling module used in the Block and File VNX5300 platform SPs (A and B).

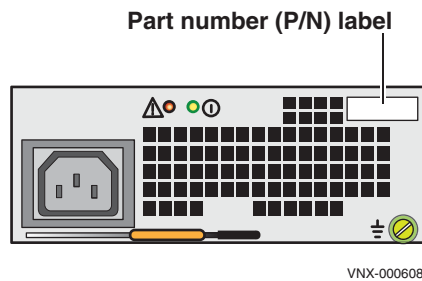

Figure 8 Example of a power supply module/cooling

Table 5 lists the part number label location, part number, description, and whether it is a FRU or CRU.

Table 5 Power supply module/cooling fan part number

Part number label location (Figure 8)	Part number	Description	FRU	CRU
	071-000-529	1U AC/DC, 875W, dual power supply	✓	

SP

Figure 9 shows the part number label location on the SP.

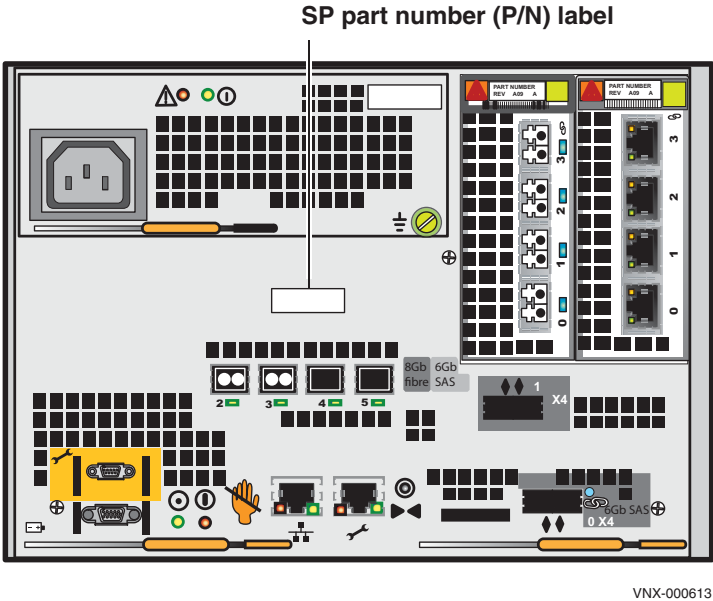

Figure 9 Example of an SP

Table 6 lists the part number label location, part number, description, and whether it is a FRU or CRU.

Table 6 SP CPU part number

Part number label location (Figure 9 on page 13)	Part number	Description	FRU	CRU
	110-140-408B	SP 1.6-GHZ CPU, with 8 GB of memory		
	110-140-400B	SP 1.6-GHZ CPU, without memory	✓	

To access the SP CPU, you must first remove the SP from the 3U DPE (Figure 10 on page 14). Then, you must remove the power supply/cooling fan modules (Figure 11 on page 14).

Figure 10 shows the SP partially removed from the front of the DPE.

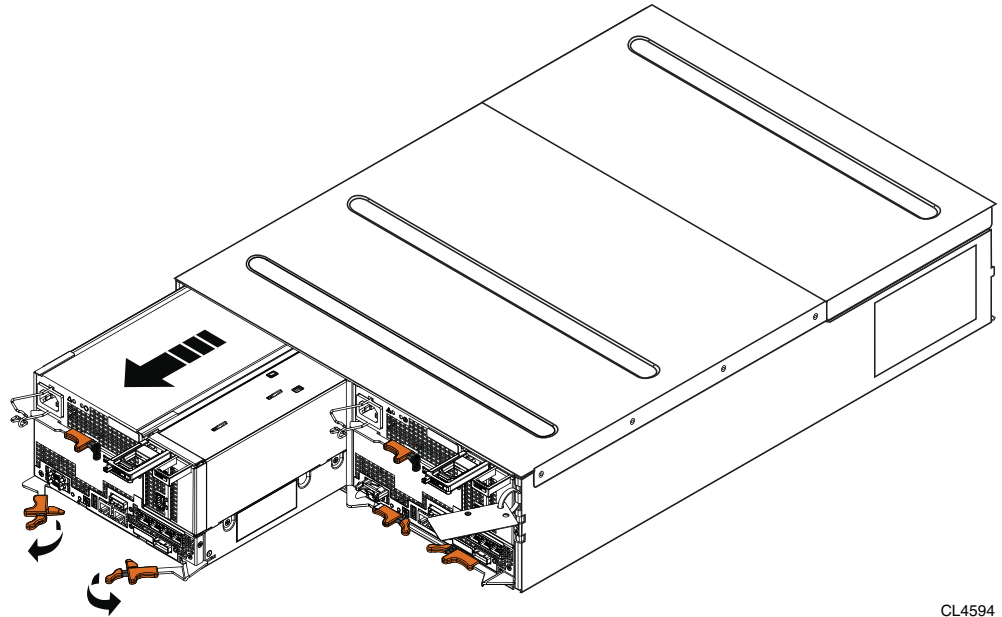

CL4594

Figure 10 Example of removing the SP from the 3U DPE

Figure 11 shows the power supply/cooling module being removed from the SP.

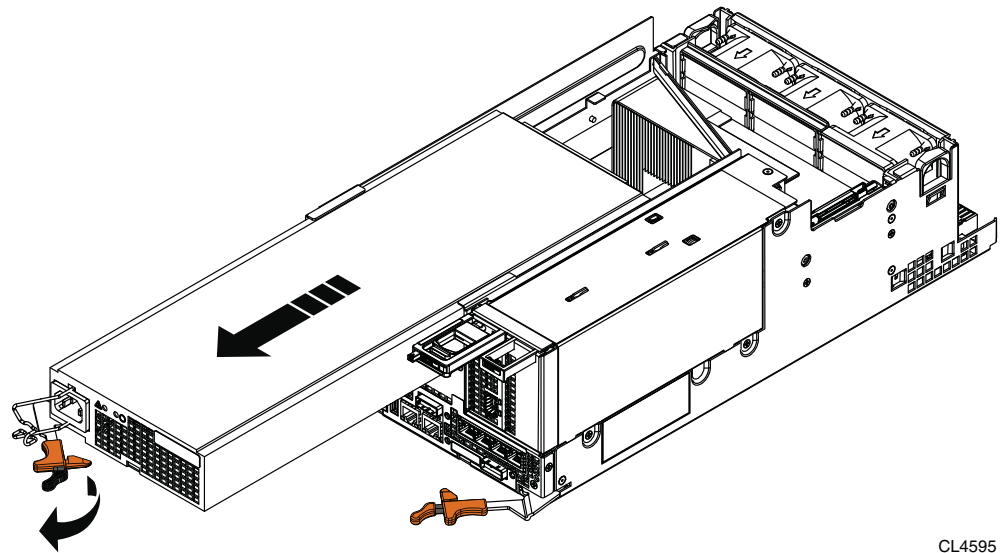

CL4595

Figure 11 Example of removing the SP power supply/cooling module from the SP

The part number labels for the SP and the SP CPU module in [Figure 12](#) are listed in [Table 6 on page 13](#). The SP CPU part number label is located on the motherboard of the SP CPU ([Figure 12](#)).

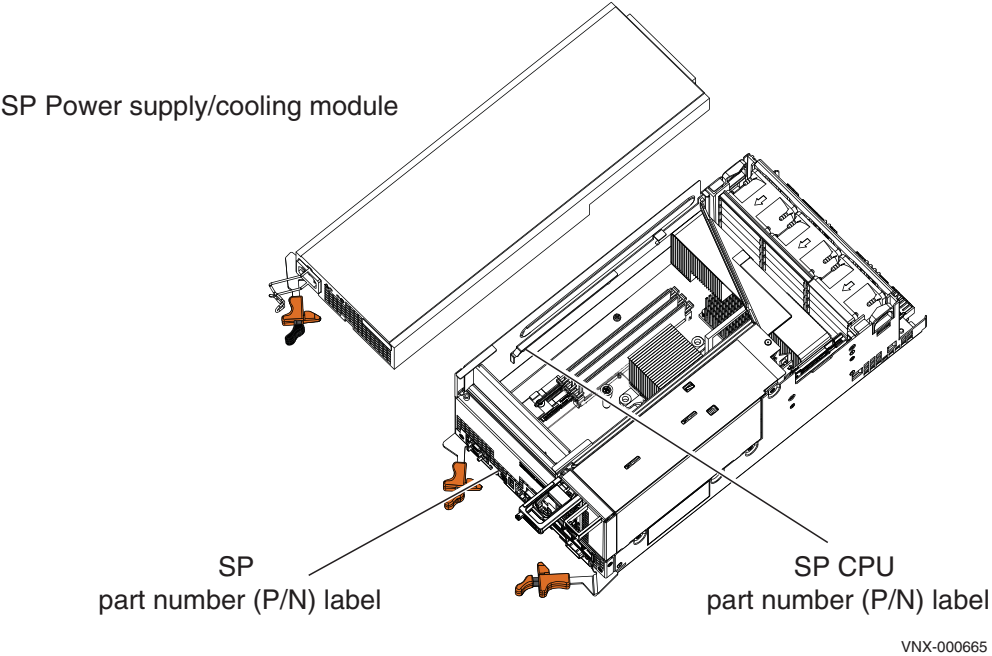
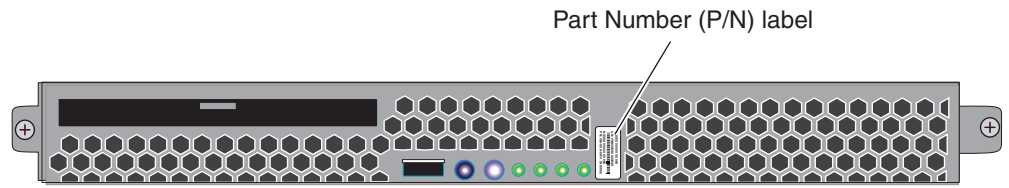

Figure 12 Example of the SP CPU with power supply/cooling module set aside

Control Station

Figure 13 shows the part number label location on the front of the 1U Control Station.



CNS-001544

Figure 13 Example of the Control Station (front view)

Table 7 lists the part number label location, part number, description, and whether it is a FRU or CRU.

Table 7 Control Station front view part number

Part number label location (Figure 13)	Part number	Description	FRU	CRU
	100-520-665	Control Station (CS) 1U	✓	

Data Mover enclosure

Figure 14 shows the part number location on the front of the 2U Data Mover enclosure.

Front view

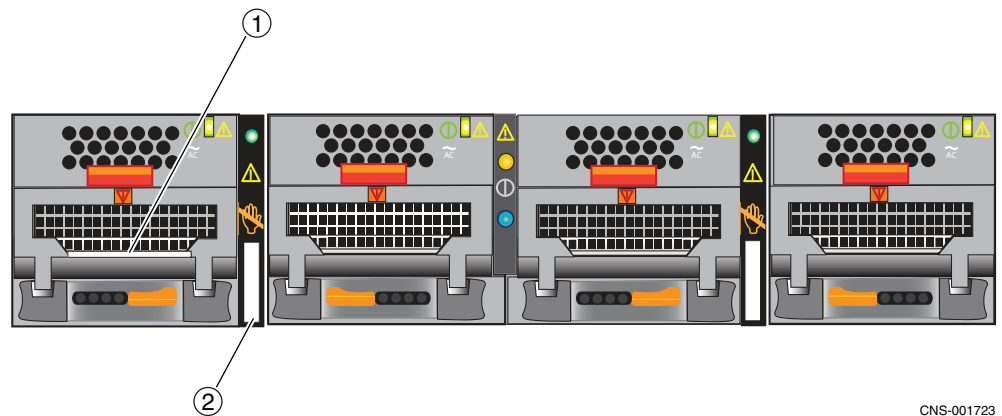

CNS-001723

Figure 14 Data Mover enclosure (front view)

Table 8 provides the part number label location, part number, description, and whether it is a FRU or CRU.

Table 8 Data Mover enclosure front view part numbers

Part number label location (Figure 14 on page 16)	Part number	Description	FRU	CRU
1	071-000-543 ¹	Data Mover enclosure 400 W, 2U, single 12 V output power supply/cooling fan module (for a closer view, see Figure 15 on page 17)	✓	✓
2	110-113-102B	Data Mover 2.4-GHz CPU module with 6 GB of memory (for a closer view, see Figure 17 on page 19)		
	303-113-101B	Data Mover 2.4-GHz CPU module without memory (for a closer view, see Figure 17 on page 19)	✓	✓

1. The part number label on the power supply/cooling fan module is located on the lower half of the pull handle.

Data Mover Power supply/cooling fan module

Figure 15 shows the part number label location on the front of the two power supply/cooling fan modules used in the Data Mover enclosure.

Note: The part number label is located on the lower half of the pull handle.

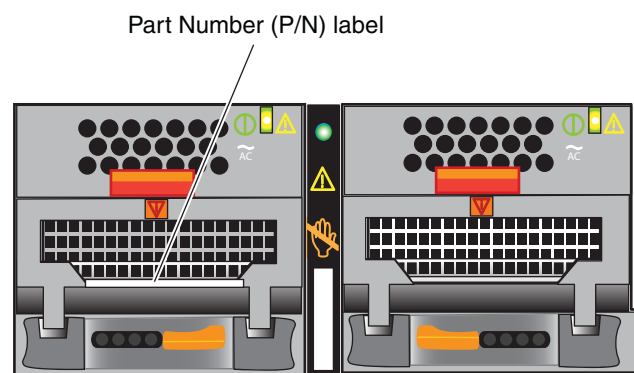

CNS-001682

Figure 15 Example of a power supply module/cooling fan (front view)

Table 9 lists the part number label location, part number, description, and whether it is a FRU or CRU.

Table 9 Power supply module/cooling fan part number

Part number label location (Figure 15 on page 17)	Part number	Description	FRU	CRU
	071-000-543	Data Mover enclosure 400 W, 2U, single 12 V output power supply/cooling fan module	✓	✓

Data Mover CPU module

To access the Data Mover CPU, you must first remove the power supply/cooling fan modules (Figure 16).

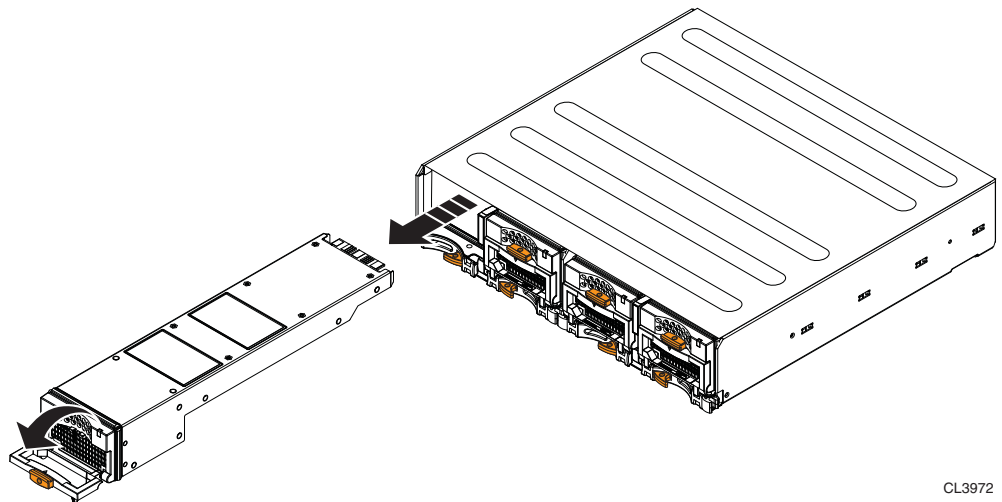

CL3972

Figure 16 Example of the Data Mover power supply/cooling fan module removal

Figure 17 on page 19 shows the Data Mover CPU module partially removed from the front of the Data Mover enclosure with the two power supply/cooling fan modules set aside. The part number label for the Data Mover CPU module in Figure 17 on page 19 is listed in Table 10 on page 19.

Note: The DM CPU part numbers are located on the DM CPU sheet metal. You must remove the DM from the DM enclosure (Figure 17 on page 19). You can also find the DM CPU part number label located inside the DM CPU by looking through the blue plastic DIMM cover. The part number label is located on the motherboard.

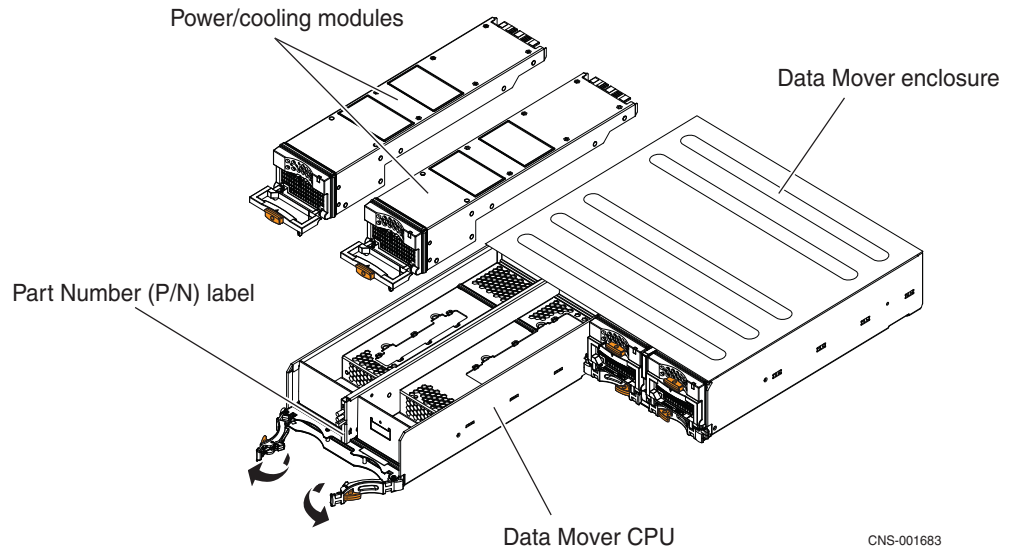

CNS-001683

Figure 17 Example of the Data Mover CPU being removed from a Data Mover enclosure

Table 10 Data Mover CPU part number

Part number label location	Part number	Description	FRU	CRU
Figure 14 on page 16	110-113-102B	Data Mover 2.4-GHz CPU module with 6 GB of memory		
Figure 17 on page 19	303-113-101B	Data Mover 2.4-GHz CPU module without memory	✓	

Rear view

[Figure 18](#) shows the part number label location on the rear of a Data Mover enclosure.

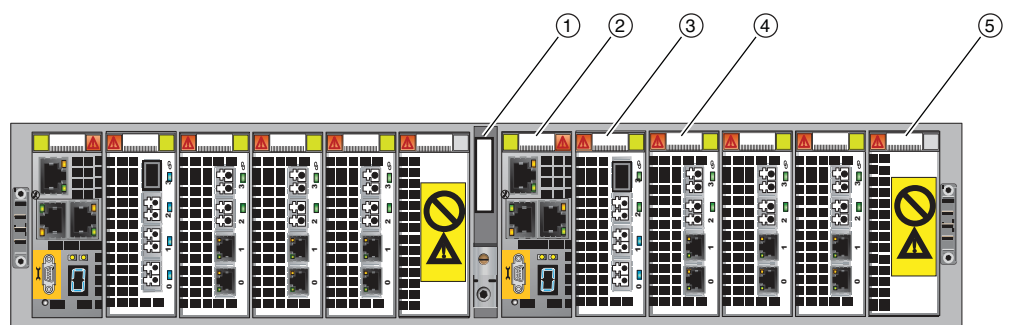

CNS-001724

Figure 18 Data Mover enclosure (rear view)

Table 11 lists the part number label location, part number, description, and whether it is a FRU or CRU.

Table 11 Data Mover enclosure part numbers rear view

Part number label location (Figure 18 on page 19)	Part number	Description	FRU	CRU
1	100-562-178	Data Mover enclosure (empty)	✓	
2	110-130-100B	Management module (for a closer view, see Figure 19 on page 21)	✓	✓
3	303-092-102B	Four-port 8-Gb/s Fibre Channel (FC) I/O module (for a closer view, see Figure 20 on page 23)	✓	✓
4	303-122-100A	Two-port 1-Gb/s copper plus two-port 1G/bs optical I/O module (for a closer view, see Figure 25 on page 28)	✓	✓
5	100-562-718	I/O module filler panel includes Do Not Remove label Note: This filler panel is only used when the Data Mover I/O module slots are empty.	✓	✓
	303-121-100A ¹	Four-port 10/100/1000 Base-T copper I/O module (for a closer view, see Figure 27 on page 30)	✓	✓
	303-081-103B ²	Two-port 10-Gb/s Ethernet optical I/O module (for a closer view, see Figure 26 on page 29)	✓	✓
	303-195-100B ³	Two-port 10-Gb/s Ethernet optical or Twinax I/O module (for a closer view, see Figure 28 on page 31)	✓	✓
	303-164-104D-01 ⁴	Two-port 10-Gb/s RJ-45 Base-T iSCSI/IP (for a closer view, see Figure 24 on page 27)	✓	✓

1. This part is not shown in the example Data Mover enclosure illustration in Figure 18 on page 19. For a closer view, go to Figure 27 on page 30.
2. This part is not shown in the example Data Mover enclosure illustration in Figure 18 on page 19. For a closer view, go to Figure 22 on page 25.
3. This part is not shown in the example Data Mover enclosure illustration in Figure 18 on page 19. For a closer view, go to Figure 28 on page 31.
4. This part is not shown in the example Data Mover enclosure illustration in Figure 18 on page 19. For a closer view, go to Figure 24 on page 27.

Management module

Figure 19 shows the part number label location on the rear of the Data Mover enclosure management module used in the Data Mover enclosure.

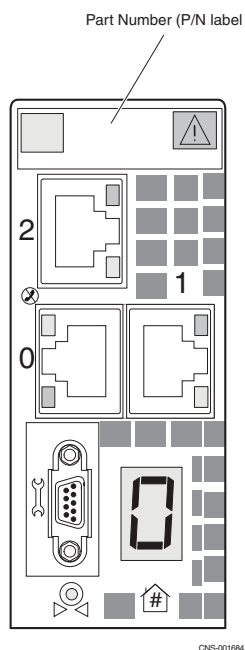

Figure 19 Example of the Data Mover enclosure management module

Table 12 lists the part number label location, part number, description, and whether it is a FRU or CRU.

Table 12 Data Mover enclosure management module part number

Part number label location (Figure 19)	Part number	Description	FRU	CRU
	110-130-100B	Management module	✓	✓

I/O modules

In the Block and File VNX5300 platform, I/O modules are used in the disk processor enclosure (DPE) storage processors (SP A and B) and in the Data Movers of the Data Mover enclosure.

Each I/O module is identified by a part number, type of ports (copper or optical), latch handle label, and color label on top of the latch handle. For ease of identification, Table 13 on page 22 describes each I/O module type in the VNX5300.

Table 13 I/O module types for VNX5300

I/O module	Part number	Ports	Latch handle label	Latch handle label color
Four-port 8-Gb/s FC	303-092-102B	Optical	8 Gb Fibre	Silver
Four-port 1-Gb/s	303-141-100A	Copper	1 GbE iSCSI/TOE	Orange
Two-port 10-Gb/s (w/iSCSI)	303-081-105B	Optical	10 GbE	Orange
Two-port 10-Gb/s FCoE	303-142-100A	Optical	10 GbE/FCoE	Green
Two-port 10-Gb/s RJ-45 Base-T iSCSI/IP	303-164-104D-01	Copper	10 GbE Base-T	Orange
Two-port 1-Gb/s copper plus two-port 1-Gb/s optical	303-122-100A or B	Copper plus optical	1 GbE	Brown
Two-port 10-Gb/s	303-081-103B or C	Optical	10 GbE iSCSI or 10 GbE v2	Orange
Two-port 10-Gb/s	303-195-100C-01	Optical	10 GbE v3	Orange
Four-port 10/100/1000 Ethernet	303-121-100A	Copper	1 GbE	Brown

SP

Five types of I/O modules are supported in the SP:

- ◆ [“Four-port 8-Gb/s Fibre Channel \(FC\) I/O module” on page 23](#)
- ◆ [“Four-port 1-Gb/s copper iSCSI I/O module” on page 24](#)
- ◆ [“Two-port 10-Gb/s optical \(w/iSCSI protocol\) I/O module” on page 25](#)
- ◆ [“Two-port 10-Gb/s Fibre Channel over Ethernet \(FCoE\) I/O module” on page 26](#)
- ◆ [“Two-port 10-Gb/s RJ-45 Base-T iSCSI/IP I/O module” on page 27](#)

Data Mover

Seven types of I/O modules are supported in the Data Mover:

- ◆ [“Four-port 8-Gb/s Fibre Channel \(FC\) I/O module” on page 23](#)
- ◆ [“Two-port 10-Gb/s Fibre Channel over Ethernet \(FCoE\) I/O module” on page 26](#)
- ◆ [“Two-port 10-Gb/s RJ-45 Base-T iSCSI/IP I/O module” on page 27](#)
- ◆ [“Two-port 1-Gb/s copper plus two-port 1-Gb/s optical I/O module” on page 28](#)
- ◆ [“Two-port 10-Gb/s optical I/O module” on page 29](#)
- ◆ [“Four-port 1-Gb/s copper I/O module” on page 30](#)
- ◆ [“Two-port 10-Gb/s optical I/O module” on page 31](#)

The following sections describe these I/O modules and the part numbers. Refer to these when determining which part number you need for either the SP or Data Mover that the I/O module goes in.

Four-port 8-Gb/s Fibre Channel (FC) I/O module

Figure 20 shows the part number label location on the four-port 8-Gb/s Fibre Channel (FC) I/O module (labeled **8 Gb Fibre** on the latch handle).

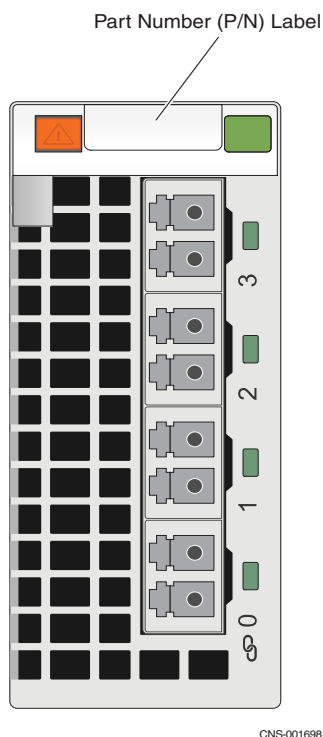

Figure 20 Example of the four-port 8-Gb/s FC I/O module

Table 14 lists the part number label location, part number, description, and whether it is a FRU or CRU.

Table 14 Four-port 8-Gb/s FC I/O module part numbers

Part number label location (Figure 20)	Part number	Description	FRU	CRU
	303-092-102B	Four-port 8-Gb/s FC (2/4/8 Gb/s)	✓	✓

Four-port 1-Gb/s copper iSCSI I/O module

Figure 21 shows the part number label location on the four-port 1-Gb/s copper iSCSI I/O module (labeled 1 GbE iSCSI/TOE on the latch handle).

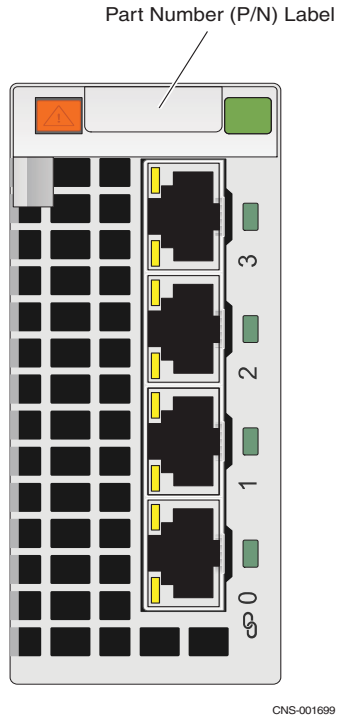

Figure 21 Example of the four-port 1-Gb/s copper iSCSI I/O module

Table 15 lists the part number label location, part number, description, and whether it is a FRU or CRU.

Table 15 Four-port 1-Gb/s copper iSCSI I/O module part number

Part number label location (Figure 21)	Part number	Description	FRU	CRU
	303-141-100A	Four 1-Gb/s copper iSCSI ports	✓	✓

Two-port 10-Gb/s optical (w/iSCSI protocol) I/O module

Figure 22 shows the part number label location on the two-port 10-Gb/s optical (w/iSCSI protocol) I/O module (labeled **10 GbE** on the latch handle).

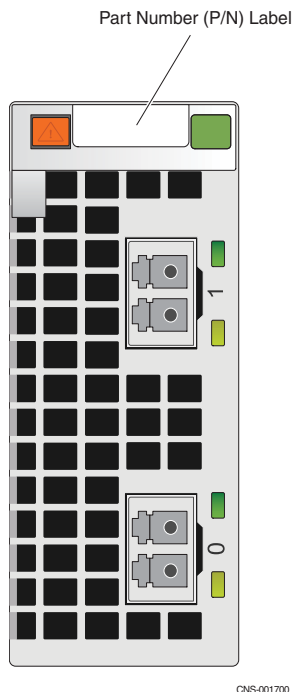

Figure 22 Example of the two-port 10-Gb/s optical (w/iSCSI protocol) I/O module

Table 16 lists the part number label location, part number, description, and whether it is a FRU or CRU.

Table 16 Two-port 10-Gb-s optical (w/iSCSI protocol) I/O module part number

Part number label location (Figure 22)	Part number	Description	FRU	CRU
	303-081-105B	Two-port 10-Gb/s optical (w/iSCSI protocol) I/O module	✓	✓

Two-port 10-Gb/s Fibre Channel over Ethernet (FCoE) I/O module

Figure 23 shows the part number label location on the two-port 10-Gb/s Fibre Channel over Ethernet (FCoE) I/O module (labeled **10 GbE/FCoE** on the latch handle).

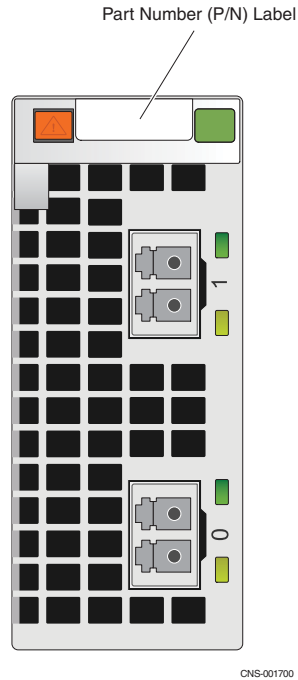

Figure 23 Example of the two-port 10-Gb/s FCoE I/O module with SFPs¹

Note: The 10-Gb/s FCoE I/O module requires VNX OE for File version 7.0.35.3 or later.

Table 17 shows the part number label location, part number, description, and whether it is a FRU or CRU.

Table 17 Two-port 10-Gb/s FCoE I/O module part numbers

Part number label location (Figure 23)	Part number	Description	FRU	CRU
	303-142-100A	Two-port 10-Gb/s FCoE	✓	✓

1. The FCoE I/O module can also use twinaxial (Twinax) cables. Twinax is a type of cable similar to coax, but with two inner conductors instead of one. These cables will be supplied in lieu of SFPs when so ordered.

Two-port 10-Gb/s RJ-45 Base-T iSCSI/IP I/O module

Figure 26 shows the part number label location on the two-port 10-Gb/s RJ-45 Base-T iSCSI/IP I/O module (labeled **10 GbE BASE-T** on the latch handle).

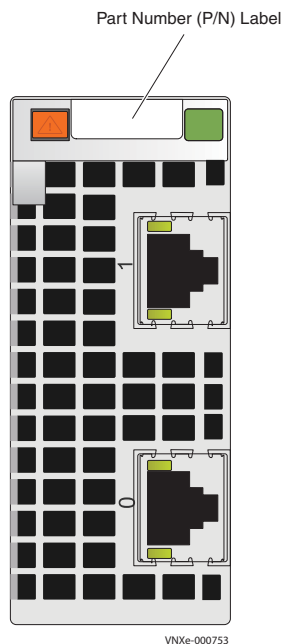

Figure 24 Example of the two-port 10-Gb/s RJ-45 Base-T iSCSI/IP I/O module

Note: The two-port 10-Gb/s RJ-45 Base-T iSCSI/IP I/O module requires VNX OE for File 7.1 or later.

Table 20 shows the part number label location, part number, description, and whether it is a FRU or CRU.

Table 18 Two-port 10-Gb/s RJ-45 Base-T iSCSI/IP I/O module part number

Part number label location (Figure 24)	Part number	Description	FRU	CRU
	303-164-104D-01	Two-port 10-Gb/s RJ-45 Base-T iSCSI/IP I/O module	✓	✓

Two-port 1-Gb/s copper plus two-port 1-Gb/s optical I/O module

Figure 25 shows the part number label location on the two-port 1-Gb/s copper plus two-port 1-Gb/s optical I/O module (labeled **1 GbE** on the latch handle).

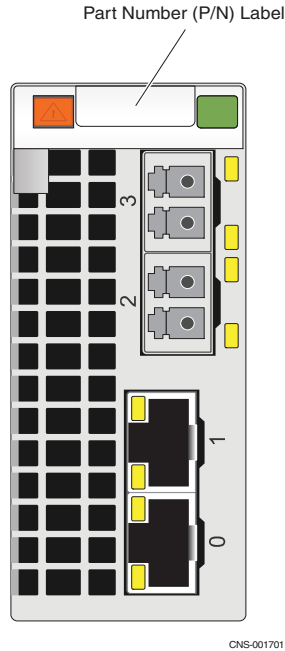

Figure 25 Example of the two-port 1-Gb/s copper plus two-port 1-Gb/s optical I/O module

Table 19 lists the part number label location, part number, description, and whether it is a FRU or CRU.

Table 19 Two-port 1-Gb/s copper plus two-port 1-Gb/s optical I/O module part number

Part number label location (Figure 25)	Part number	Description	FRU	CRU
	303-122-100A or B	Two-port 1-Gb/s copper plus two-port 1-Gb/s optical	✓	✓

Two-port 10-Gb/s optical I/O module

Figure 26 shows the part number label location on the two-port 10-Gb/s optical I/O module (labeled **10 GbE iSCSI** or **10 GbE v2** on the latch handle).

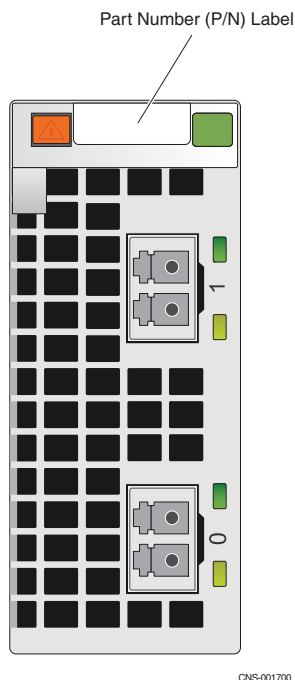

Figure 26 Example of the two-port optical I/O module

Table 20 shows the part number label location, part number, description, and whether it is a FRU or CRU.

Table 20 Two-port optical I/O module part number

Part number label location (Figure 26)	Part number	Description	FRU	CRU
	303-081-103B or C	Two-port 10-Gb/s optical I/O module	✓	✓

Four-port 1-Gb/s copper I/O module

Figure 27 shows the part number label location on the four-port 1-Gb/s copper I/O module (labeled **1 GbE** on the latch handle).

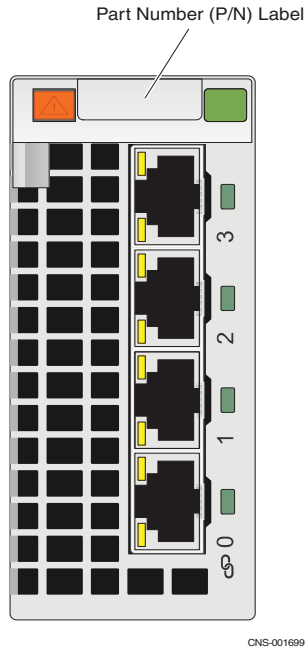

Figure 27 Example of the four-port 1-Gb/s copper I/O module

Table 21 shows the part number label location, part number, description, and whether it is a FRU or CRU.

Table 21 Four-port 1-Gb/s copper I/O module part number

Part number label location (Figure 27)	Part number	Description	FRU	CRU
	303-121-100A	Four 1-Gbs copper ports	✓	✓

Two-port 10-Gb/s optical I/O module

Figure 26 shows the part number label location on the two-port 10-Gb/s optical or active Twinax I/O module (labeled **10 GbE v3** on the latch handle).

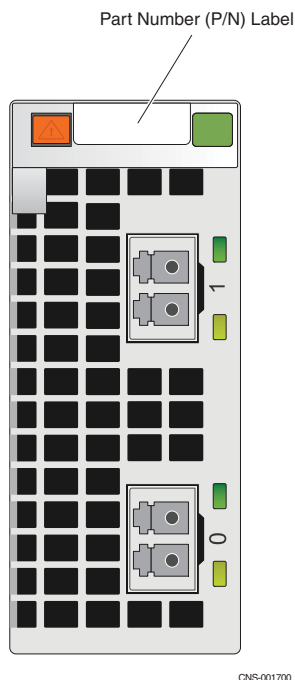

Figure 28 Example of the two-port 10-Gb/s optical I/O module

Note: This two-port 10-Gb/s optical I/O module requires VNX OE for File version 7.1 or later.

Table 22 shows the part number label location, part number, description, and whether it is a FRU or CRU.

Table 22 Two-port 10-Gb/s optical I/O module part number

Part number label location (Figure 28)	Part number	Description	FRU	CRU
	303-195-100C-01	Two-port 10-Gb/s Optical I/O module	✓	✓

Small form-factor pluggable (SFP)

Small form-factor (SFP) modules are compact, hot-pluggable transceivers inserted into the SFP or SFP+ slot of an I/O module in a Block and File VNX5300 platform. This transceiver module provides uplink optical interfaces, laser send or transmit (TX) and laser receive (RX). An SFP or SFP+ transceiver module is hot-swappable. You can replace an SFP or SFP+ from the rear of the SP or Data Mover while the platform is powered up.

Note: The part number is visible only when the SFP or SFP+ is removed from the I/O module port.

Laser safety guidelines

Before you install SFP or SFP+ modules in a Block and File VNX5300 platform or attempt to operate or service a Block and File VNX5300 platform equipped with SFP modules, you must read and observe the important safety information in this section of the document.

The Block and File VNX5300 platform SFP or SFP+ modules are equipped with a Class 1 Laser, which emits invisible radiation. Do not stare into open optical ports. The following warnings apply to the all SFP and SFP+ modules.



Class 1 laser product.

Because invisible laser radiation can be emitted from the aperture of the port when no fiber is connected, avoid exposure to laser radiation and do not stare into open apertures.

Laser radiation is present when the system is open and interlocks bypassed.

Only trained and qualified personnel should be allowed to install, replace, or service this equipment.

Guidelines for handling SFP and SFP+ modules

Use these guidelines when you work with SFP and SFP+ modules:

- ◆ SFP and SFP+ modules are static sensitive. Wear an ESD-preventive wrist strap that is connected to the rack in order to prevent ESD damage.
- ◆ SFP and SFP+ modules are dust sensitive. Always store the devices with dust plugs installed in the optical bores.
- ◆ Do not remove and insert an SFP or SFP+ module more often than is necessary. Repeated removals and insertions of an SFP or SFP+ module can shorten its useful life.

Types of SFP and SFP+ module latches

SFP transceiver modules can have three types of latching devices to secure the SFP or SFP+ transceiver in a port socket.

- ◆ SFP or SFP+ transceiver with a Mylar tab latch.
- ◆ SFP or SFP+ transceiver with an actuator button latch.
- ◆ SFP or SFP + transceiver that has a bale-clasp latch.

I/O modules using SFP or SFP+ transceiver modules

In the VNX5300 platform, the SFP or SFP+ transceiver modules are located in the ports of the following I/O modules:

- ◆ Four-port 8-Gb/s Fibre Channel (FC) for 2, 4, and 8 Gb/s speed
- ◆ Two-port 1-Gb/s copper plus two-port 1-Gb/s optical
- ◆ Two-port 10-Gb/s optical (labeled **10 GbE iSCSI** or **10 GbE v2**)
- ◆ Two-port 10-Gb/s optical² (labeled **10 GbE v3**)
- ◆ Two-port 10-Gb/s Fibre Channel over Ethernet (FCoE)³

Types of SFP and SFP+ modules

Three types of SFP or SFP+ modules are used in the I/O modules of the Block and File VNX5300 platform. [Figure 29 on page 34](#) shows an example of an SFP or SFP+ with a bale clasp and the part number label.

IMPORTANT

Ensure that you correctly match the SFP or SFP+ module type with the I/O module type.

2. The 10 Gb/s module (labeled **10 GbE v3**) can also use active twinaxial (Twinax) cables. Twinax is a type of cable similar to coax, but with two inner conductors instead of one. These cables will be supplied in lieu of SFPs when so ordered.
3. The FCoE I/O module can also use active twinaxial (Twinax) cables. Twinax is a type of cable similar to coax, but with two inner conductors instead of one. These cables will be supplied in lieu of SFPs when so ordered.

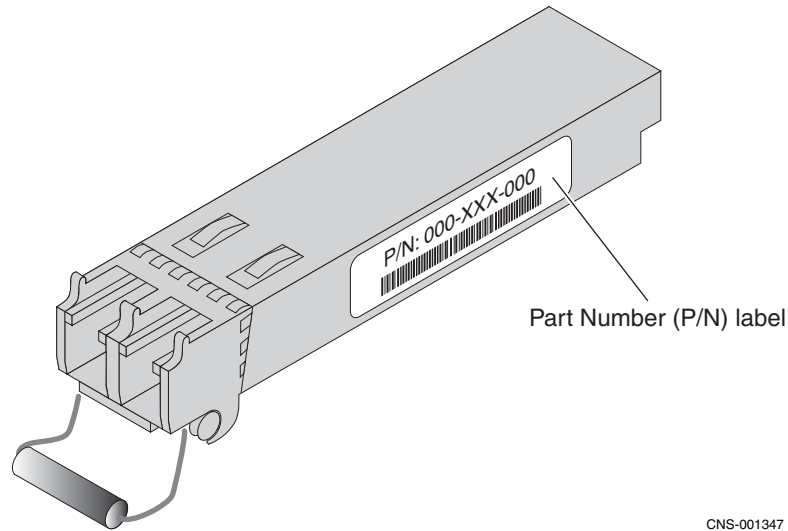

Figure 29 Example of an SFP with a bale clasp

Table 23 lists the part number label location, part number, description, and whether it is a FRU or CRU.

Note: The SFP or SFP+ part number is visible only when the SFP or SFP+ is removed from an I/O module port.

Table 23 SFP and SFP+ module part numbers

Part number label location (Figure 29)	Part number	Description	FRU	CRU
	019-078-032 (SFP)	Used in the two-port 1-Gb/s copper plus two-port 1-Gb/s Optical I/O module (see note)	✓	✓
	019-078-041 (SFP+)	Used in the two-port 10-Gb/s FCoE I/O module	✓	✓
		Used in the two-port 10-Gb/s optical I/O module (latch label 10 GbE iSCSI or v2)	✓	✓
		Used in the two-port 10-Gb/s optical I/O module (latch label 10-GbE v3)	✓	✓
	019-078-042 (SFP+)	Used in the four-port 8-Gb/s Fibre Channel (FC) I/O module	✓	✓
<p>Note: Only the two optical ports (physically labeled on this I/O module as 2 and 3, but logically fge-x-2 and fge-x-3) use this type of SFP.</p>				

DIMMs

The Storage Processor (SP) requires 4 GB per SP or a total of 8 GB per array and the Data Mover requires 6 GB per Data Mover.

SP DIMMs

The SP CPU uses SDRAM DIMMs⁴. Each SP uses three 4-GB unbuffered Double-Data-Rate 3 (DDR3) type memory for a total of 12 GB per SP or 24 per DPE or array. [Figure 30 on page 36](#) shows an example of the location of the SP DIMM slots.

IMPORTANT

The DIMM part numbers are visible only when you remove the DIMM from the DIMM slot. You must first take the SP out of service, disconnect any SP cables, remove the SP from the DPE, then remove the SP power supply/cooling module from the SP (see [Figure 10 on page 14](#), [Figure 11 on page 14](#), and [Figure 12 on page 15](#)). With the SP CPU laying on an antistatic mat, lift the DIMM cover up in the SP CPU, and then remove the DIMM from the DIMM slot. Ensure that you remove only those DIMMs that you intend to replace. For more information about removing and installing the DIMM or memory module, refer to the *Replacing a memory module* procedure available from the VNX Procedure Generator program.

⚠ CAUTION

The DIMM memory is *not* hot-swappable. Before removing or replacing any DIMMs, you must follow the removing and installing the DIMM or memory module procedure described in the *Replacing a memory module* procedure available from the VNX Procedure Generator program.

⚠ CAUTION

Note the orientation of the VNX5300 Block and File platform SP DIMMs (see locations DIMM 0, DIMM 1, and DIMM 2 in [Figure 30 on page 36](#)). A label on the DIMM cover also identifies the DIMM slots as DIMM 0, DIMM 1, and DIMM 2. In the VNX5300 Block and File platform, the SP DIMMs are placed in slots 0, 1, and 2.

4. The term DIMM is used throughout this guide. The term DIMM is also referred to as a memory module. These terms are interchangeable and basically mean the same thing.

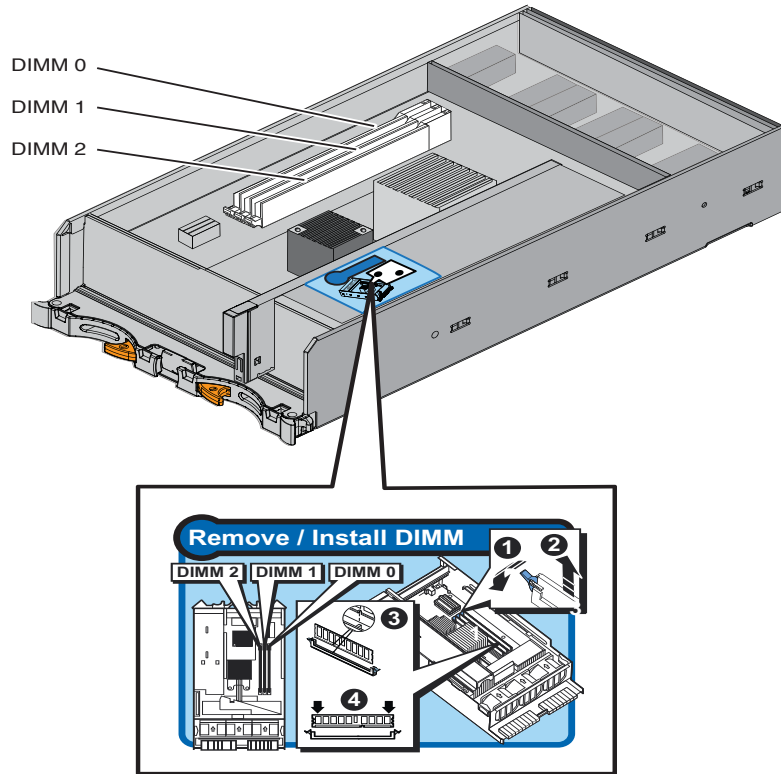

VNX-000610

Figure 30 Example of the Block and File VNX5300 platform SP DIMM slot location

Figure 31 shows the part number label location of the SP DIMM.

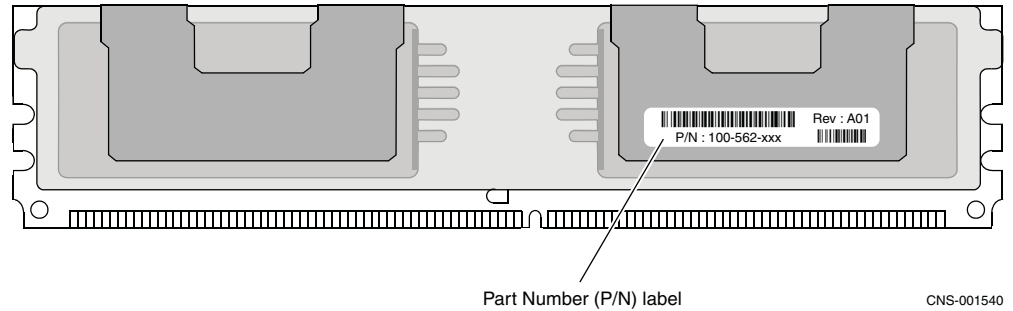

Figure 31 Example of the Block and File VNX5300 platform SP DIMM part number location

Table 24 lists the SP DIMM part number location, description, and whether it is a FRU or CRU.

Table 24 VNX5300 platform SP CPU DIMM part numbers

Part number label location (Figure 31)	Part number	Description	FRU	CRU
	100-563-325	Two 4-GB Unbuffered DDR3 DIMMs per CPU module on one SP	✓	

Data Mover DIMMs

Data Mover DIMMs are 2-GB SDRAM type memory. Figure 32 on page 38 shows an example of the Data Mover DIMM slot location and with a part number label. Figure 33 on page 39 shows the part number label location.

IMPORTANT

The DIMM part numbers are visible only when you remove the DIMM from the DIMM slot. You must first take the Data Mover out of service, disconnect any Data Mover cables, remove the Data Mover from the DME, then remove the Data Mover power supply/cooling module from the Data Mover (see Figure 16 on page 18 and Figure 17 on page 19). With the Data Mover CPU laying on an antistatic mat, lift the DIMM cover up in the Data Mover CPU, and then remove the DIMM from the DIMM slot. Ensure that you remove only those DIMMs that you intend to replace. For more information about removing and installing the DIMM or memory module, refer to the *Replacing a memory module* procedure available from the VNX Procedure Generator program.

CAUTION

The DIMM memory is *not* hot-swappable. Before removing or replacing any DIMMs, you must follow the removing and installing the DIMM or memory module procedure described in the *Replacing a memory module* procedure available from the VNX Procedure Generator program.

CAUTION

Note the orientation of the VNX5300 Block and File platform Data Mover DIMMs (see locations DIMM 0, DIMM 1, DIMM 2, DIMM 3, DIMM 4, and DIMM 5 in [Figure 32 on page 38](#)). A label on the DIMM cover also identifies the DIMM slots as DIMM 0, DIMM 1, DIMM 2, DIMM 3, DIMM 4, and DIMM 5. In the VNX5300 Block and File platform, the Data Mover DIMMs are placed in slots 0, 2, and 4. Slots 1, 3, and 5 are left empty.

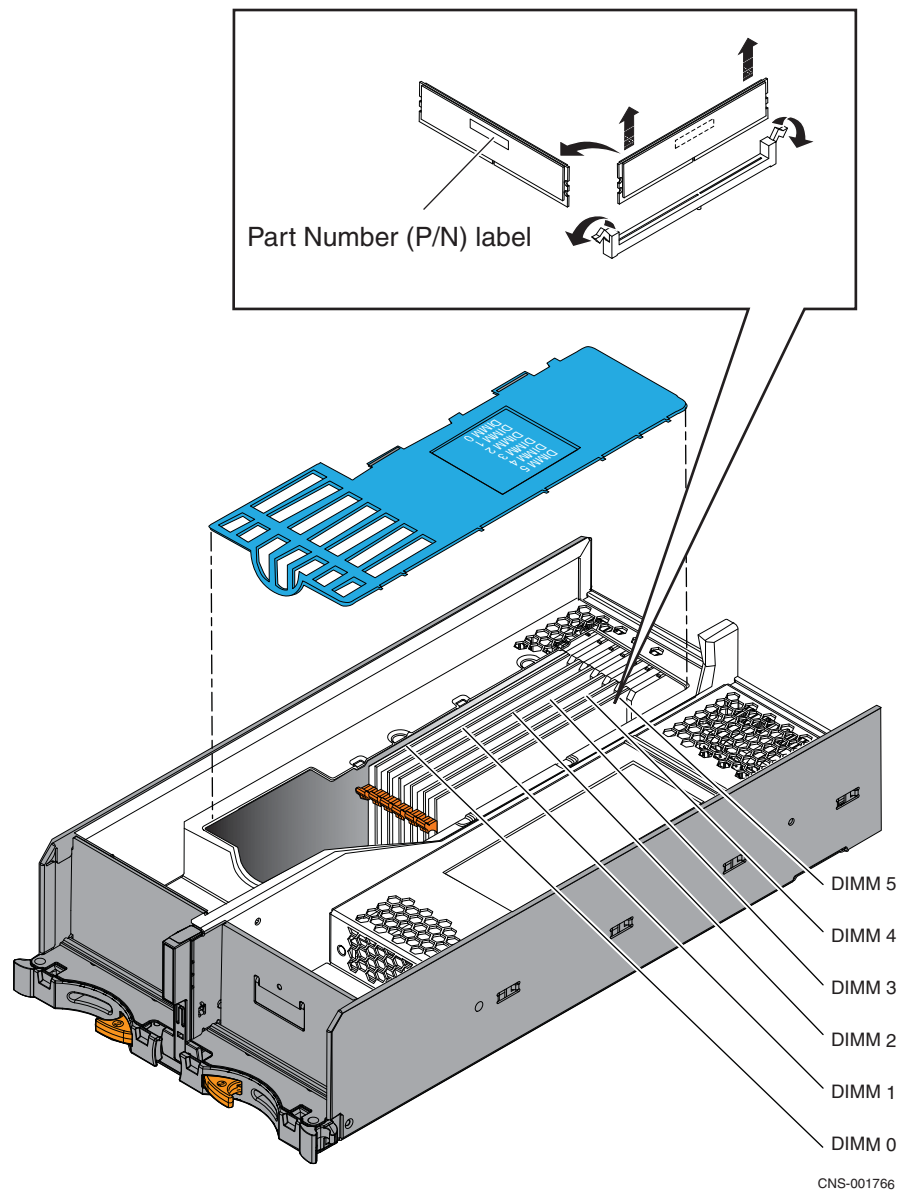

Figure 32 Example of the Block and File VNX5300 platform Data Mover DIMM slot location

Figure 33 shows the Data Mover DIMM part number label location.

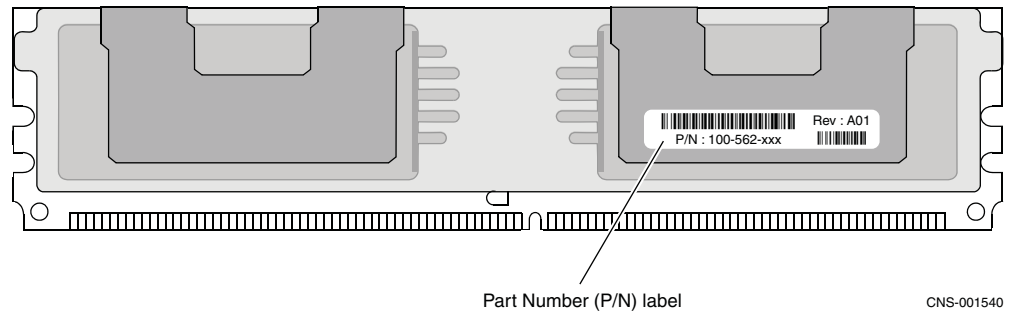

Figure 33 Example of the Block and File VNX5300 platform Data Mover DIMM part number location

Table 25 lists the Data Mover DIMM part number label location, part number, description, and whether it is a FRU or CRU.

Table 25 VNX5300 platform Data Mover CPU DIMM part numbers

Part number label location (Figure 33 on page 39)	Part number	Description	FRU	CRU
	100-562-863	Three 2-GB Unbuffered DDR3 DIMMs per CPU module on one Data Mover	✓	

Disk-array enclosure (DAE)

The expansion disk-array enclosures (DAEs) have part numbers visible on both the front and rear.

Front view

The DAE has two types of disk drive carriers:

- ◆ 3U, 15 (3.5-inch) disk drive carrier
- ◆ 2U, 25 (2.5-inch) disk drive carrier

3U, 15 (3.5-inch) disk drive DAE

Figure 34 on page 40 shows the front view of the 3U, 15 (3.5-inch) disk drive DAE.

Note: You can visually distinguish disk module kinds by their type, capacity, and speed labels, and by the design of the latch and handle on each disk module (Figure 34 on page 40).



Figure 34 Example of the 3U, 15 (3.5-inch) disk drive DAE (front view)

Note: Figure 34 is for illustrative purposes only. The front of the disk modules may be a little different than the ones in your particular cabinet.

Table 26 is an example of the parts available for the 3U, 15 (3.5-inch) disk drive DAE and lists the part number label location, part number, description, and whether it is a FRU or CRU.

IMPORTANT

Due to the extensive variety of disk module types, Table 26 only lists two disk types. EMC recommends that you refer to the latest *EMC VNX5100 and VNX5300 Series Storage Systems Disk and OE Matrix Guide* to ensure that you have the correct part for your configuration.

Table 26 3U, 15 (3.5-inch) DAE disk module part numbers

Part number label location (Figure 34)	Part number	Description (see note)	FRU	CRU
	005049299	300 GB, 6 Gb/s SAS, 10k rpm	✓	✓
	005049301	600 GB, 6 Gb/s SAS, 15k rpm	✓	✓
Note: The description field describes the disk module type, capacity, drive type, and spindle speed (rpm).				

2U, 25 (2.5-inch) disk drive DAE

Figure 35 shows the front view of the 2U, 25 (2.5-inch) disk drive DAE.

Note: You can visually distinguish disk module kinds by their type, capacity, and speed labels, and by the design of the latch and handle on each disk module (Figure 35).

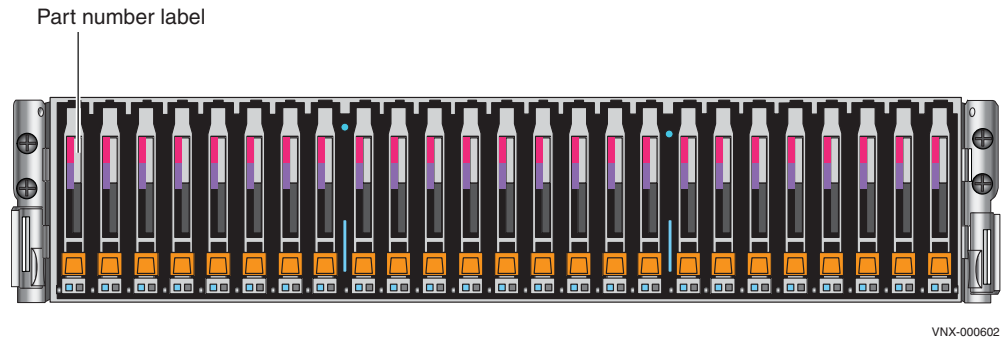

Figure 35 Example of the 2U, 25 (2.5-inch) disk drive DAE (front view)

Note: Figure 35 is for illustrative purposes only. The front of the disk modules may be a little different than the ones in your particular cabinet.

Table 27 is an example of the parts available for the 2U, 25 (2.5-inch) disk drive DAE and lists the part number label location, part number, description, and whether it is a FRU or CRU.

IMPORTANT

Due to the extensive variety of disk module types, Table 27 only lists two disk types. EMC recommends that you refer to the latest *EMC VNX5100 and VNX5300 Series Storage Systems Disk and OE Matrix Guide* to ensure that you have the correct part for your configuration.

Table 27 2U, 25 (2.5-inch) DAE disk module part numbers

Part number label location (Figure 35)	Part number	Description (see note)	FRU	CRU
	005049292	300 GB, 6 Gb/s SAS, 10k rpm	✓	✓
	005049294	600 GB, 6 Gb/s SAS, 10k rpm	✓	✓

Note: The description field describes the disk module type, capacity, drive type, and spindle speed (rpm).

Rear view

The DAE has two types of LCC modules and power supplies:

- ◆ 3U, 15 DAE LCC and power supply
- ◆ 2U, 25 DAE LCC and power supply

3U, 15 (3.5-inch) DAE LCC and power supply

Figure 36 shows the part number label location on the rear of the 3U, 15 (3.5-inch) DAE for the LCC and power supply.

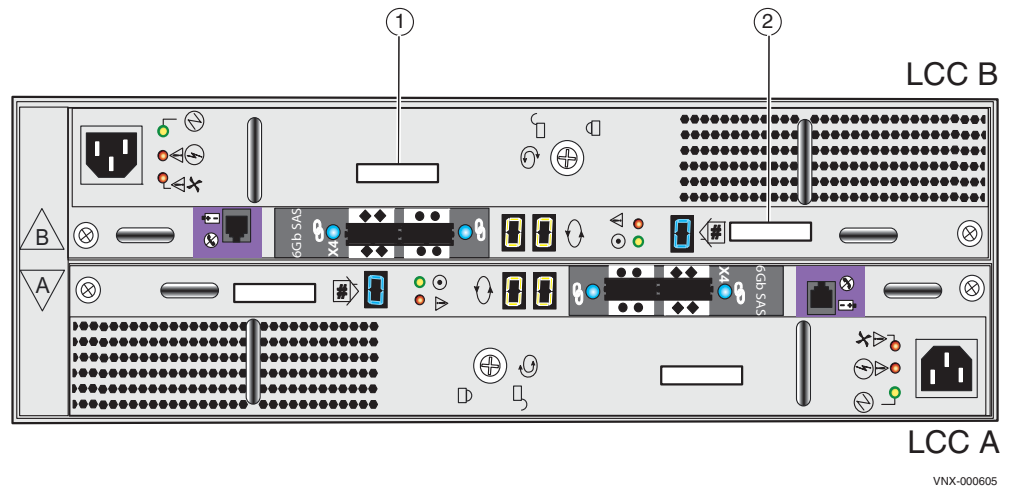

Figure 36 Example of 3U, 15 (3.5-inch) LCC

Table 28 lists the part number label location, part number, description, and whether it is a FRU or CRU.

Table 28 3U, 15 (3.5-inch) LCC part numbers

Part number label location (Figure 36)	Part number	Description	FRU	CRU
1	071-000-518	LCC B 400 W dual 12 V power supply ¹	✓	
2	303-108-000E	LCC B	✓	

1. The rear of the 3U, 15 (3.5-inch) DAE has the LCC power supply and LCC inverted or on top of each other. In other words, the LCC B power supply is located on the top of LCC B. While LCC A is located on the bottom of the DAE with LCC A on top of the LCC A power supply (Figure 36).

2U, 25 (2.5-inch) DAE LCC and power supply

Figure 37 shows the part number label location on the rear of the 2U, 25 (2.5-inch) disk drive DAE LCC and power supply.

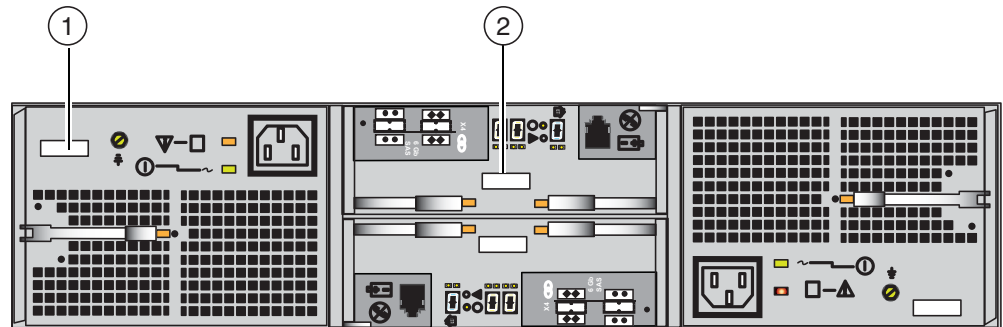

VNX-000606

Figure 37 Example of 2U, 25 (2.5-inch) DAE LCC and power supply

Table 29 lists the part number label location, part number, description, and whether it is a FRU or CRU.

Table 29 2U, 25 (2.5-inch) DAE LCC and power supply part numbers

Part number label location (Figure 37)	Part number	Description	FRU	CRU
1	071-000-541	LCC B power 400 W 12 V supply ¹	✓	
2	303-104-001E	LCC B ²	✓	

1. The rear of the 2U, 25 (2.5-inch) DAE has the LCC power supplies inverted or on opposite sides. In other words, the LCC B power supply is located on the left of the DAE and the LCC A power supply is located on the right (Figure 37).
2. The rear of the 2U, 25 (2.5-inch) DAE has the LCCs inverted or on top of each other. In other words, LCC B is located on the top and LCC A is located on the bottom (Figure 37).

Copyright © 2012 EMC Corporation. All rights reserved. Published in the USA.

Published June 26, 2012

EMC believes the information in this publication is accurate as of its publication date. The information is subject to change without notice.

The information in this publication is provided as is. EMC Corporation makes no representations or warranties of any kind with respect to the information in this publication, and specifically disclaims implied warranties of merchantability or fitness for a particular purpose. Use, copying, and distribution of any EMC software described in this publication requires an applicable software license.

EMC², EMC, and the EMC logo are registered trademarks or trademarks of EMC Corporation in the United States and other countries. All other trademarks used herein are the property of their respective owners.

For the most up-to-date regulatory document for your product line, go to the technical documentation and advisories section on EMC Online Support.